



**PNEUTORQUE<sup>®</sup>**  
**PTM & PTME SERIES**  
**INTERNAL CONTROL (IC) SHUT-OFF TOOLS**



# CONTENTS

<b>Part Numbers Covered By This Manual</b>	<b>2</b>
<b>Safety</b>	<b>3</b>
<b>Introduction</b>	<b>4</b>
Parts Included	4
Accessories	5
<b>Features and Functions</b>	<b>6</b>
<b>Set Up Instructions</b>	<b>7</b>
PneuTorque® Hanger	7
Connecting Air Supply	7
Connecting Electricity Supply	8
Air Lubrication	8
Torque Reaction	8
Clockwise / Counter-Clockwise	10
Setting Shut-Off Torque/ Angle	11
<b>Operating Instructions</b>	<b>13</b>
Tightening	13
Releasing	15
<b>Maintenance</b>	<b>16</b>
Air Lubrication	16
Gearbox	16
Silencer	16
Drive Square	17
Calibration	17
Cleaning	17
Disposal	17
<b>Specification</b>	<b>18</b>
<b>Declaration of Conformity</b>	<b>20</b>
<b>Trouble Shooting</b>	<b>21</b>
<b>Glossary of Terms</b>	<b>21</b>

# PART NUMBERS COVERED BY THIS MANUAL

This handbook covers the setup and use of Norbar PneuTorque® PTM & PTME Series Internal Control (IC) shut-off tools.

Part Number	Model	Maximum Torque
18110.B06	PTM-52-500-B-IC	500 N·m
18111.B06	PTM-52-800-B-IC	800 N·m
18112.B06	PTM-72-1000-B-IC	1000 N·m
18113.B08	PTM-72-1350-B-IC	1350 N·m
18114.B08	PTM-72-2000-B-IC	2000 N·m
18125.B06	PTM-52-500-B-IC with angle	500 N·m
18126.B06	PTM-52-800-B-IC with angle	800 N·m
18127.B06	PTM-72-1000-B-IC with angle	1000 N·m
18128.B08	PTM-72-1350-B-IC with angle	1350 N·m
18129.B08	PTM-72-2000-B-IC with angle	2000 N·m
18142.B06	PTME-72-1000-B-IC	1000 N·m
18143.B08	PTME-72-2000-B-IC	2000 N·m

**NOTE:** The main PTM & PTME models are listed above. Other PTM & PTME internal control tools with minor variances are also covered.

Description of options:

Part Number Option	Description
****.B**	Bi-directional (Clockwise and Counter-Clockwise).
****.*06	3/4" A/F drive square size.
****.*08	1" A/F drive square size.

Model Option	Description
PTM *-**-*--*-IC	PneuTorque® Twin Motor.
PTME *-**-*--*-IC	PneuTorque® Twin Motor fixed nose extension.
PTM*-52-*****-IC	52mm diameter gearbox.
PTM*-72-*****-IC	72mm diameter gearbox.
PTM*-**-1000*-IC	Maximum torque in N·m.
PTM*-**-****-B-IC	Bi-directional (Clockwise and Counter-Clockwise).

# SAFETY

**IMPORTANT: DO NOT OPERATE THE TOOL BEFORE READING THESE INSTRUCTIONS. FAILURE TO DO SO MAY RESULT IN PERSONAL INJURY OR DAMAGE TO THE TOOL.**

This tool is intended for use with threaded fasteners.

The use of ear protectors is recommended.

Do not use these tools in potentially explosive atmosphere as they contain grease, which may cause an explosion hazard in the presence of pure oxygen. These tools also contain aluminium alloy components which may cause a hazard in certain explosive environments.

Unexpected tool movement due to reaction forces or breakage of drive square or reaction bar may cause injuries.

Isolate the tool from all energy sources before changing or adjusting the drive square or socket.



There is a risk of crushing between the reaction bar and work piece.

Keep hands away from reaction bar.

Keep hands away from tool output.

Keep loose clothing, hair, etc. from being caught in any rotating part of the tool.

These tools require a reaction bar. See section on Torque Reaction.

Ensure all hoses are correctly fitted before switching on the air supply. This avoids the risk of injury by whipping air hoses.

Unexpected direction of drive square movement can cause a hazardous situation.

Use only sockets and adaptors which are in good condition and are intended for use with power tools.

PneuTorque® Wrenches are non-impacting, torque controlled threaded fastener tightening tools and must always be operated with the following:

- Clean dry air supply with a minimum flow of 19 litres/sec (40 CFM).
- Lubro Control Unit or similar Filter, Regulator and Lubricator Unit 1/2" Bore (12 mm).
- Impact or high quality sockets.
- Reaction bar.

# INTRODUCTION

The PneuTorque® PTM & PTME Internal Control (IC) tools are air driven power tools designed for applying torque to threaded fasteners. A target torque or angle value is set on the tool, when the measured torque or angle reaches this target the tool's control system shuts off the air supply for accurate and repeatable torque application. There are models to cover torque capacities of 500 N·m to 2000 N·m.

## Parts Included

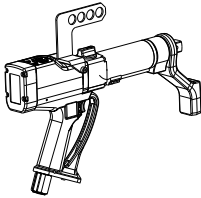
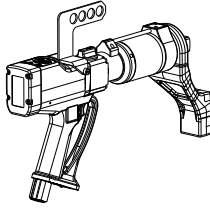
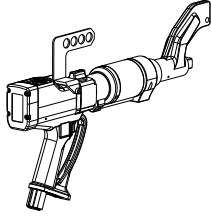
Description	Part Number		
	PTM-52	PTM-72	PTME-72
Visual difference.			
PneuTorque® power tool	18110.B06 18111.B06 18125.B06 18126.B06	18112.B06 18113.B08 18114.B08 18127.B06 18128.B08 18129.B08	18142.B06 18143.B08
Cranked reaction bar (fitted)	18646	18494	-
Reaction bar retaining circlip (fitted)	26588	26486	-
Hanger (fitted)	18747	18747	18747
Power Supply	60251	60251	60251
Power Supply Extension Lead	60252	60252	60252
Operators handbook (with language CD [if required])	34322	34322	34322

## Disposal



This symbol indicates that the product must not be disposed of in the general waste. Please dispose of according to your local recycling laws and regulations.

Contact your distributor or see the Norbar web site ([www.norbar.com](http://www.norbar.com)) for further recycling information.

## Accessories

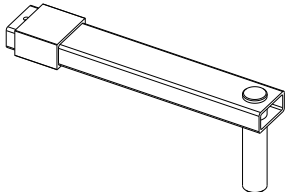
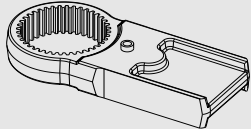
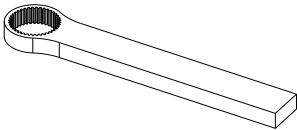
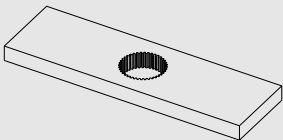
Description	Part Number		
	PTM-52	PTM-72	PTME-72
Air Coupling Socket for Hose	28933	28933	28933
Lubro Control Unit	16074	16074	16074
3/4" Drive Square (fixing screw)	18544 (25351.30)	18779 (25352.45)	-
1" Drive Square (fixing screw)	18545 (25351.30)	18492 (25352.45)	-
3/4" Drive Shaft (fixing pin)	-	-	77112.2 (26287)
1" Drive Shaft (fixing pin)	-	-	18802 (26287)
Reaction Plate [NOTE 1]			
	18298	18298	-
Reaction Adaptor [NOTE 1]			
	18558	18290	-
Single-sided Reaction Plate			
	18576	18292	-
Double-sided Reaction Plate			
	18590	18293	-
Silencer	18591	18591	18591
6" Blade Nose Extension	(3/4") 18594.006	(1") 18755.006	-
9" Blade Nose Extension	(3/4") 18594.009	(1") 18755.009	-
12" Blade Nose Extension	(3/4") 18594.012	(1") 18755.012	-
9" Nose Extension for Truck & Bus Wheels	-	(3/4") 19087.009 (1") 19089.009	-
12" Nose Extension for Truck & Bus Wheels	-	(3/4") 19087.012 (1") 19089.012	-

**NOTE 1:** Requires both 'Reaction Plate' and 'Reaction Adaptor' to be used together.

# FEATURES AND FUNCTIONS

## Twin Motor

The tools use two motors; motor 1 to quickly run-down the fastener and motor 2 to achieve final torque.

## Torque Transducer

All tools are fitted with a torque transducer, the transducer forms part of the tool and cannot be removed. The applied torque is accurately shown on the display in Newton metres (N·m) or pound force feet (lbf·ft.). The display captures the peak torque and holds this value for an operator defined time before resetting.

## Angle Measurement

The tool can be fitted with an angle sensor. The applied clockwise angle is then accurately shown on the display in degrees of rotation from an operator defined torque value. The display captures the peak angle and holds this value for an operator defined time before resetting. Angle measurement is accurate in the clockwise direction only. The angle measurement can be switched off when not required.

## Trigger

The trigger controls the flow of air. The more the trigger is pressed the more air flows into the tool. This allows for slow positioning of socket and reaction bar. Once positioning is complete, the trigger must be fully pressed for correct torque application.

## Clockwise / Counter-Clockwise Selector

Tools can tighten and release both clockwise & counter-clockwise threaded fasteners. Angle measurement is accurate in the clockwise direction only.

## Reaction Bar

The reaction bar ensures all reaction forces are contained, so that torque reaction is not passed back to the operator. Several reaction bar types are available, including the PTME / Nose Extension reaction. The PTME / Nose Extension are for use where tool access is restricted including applications on heavy vehicle wheel nuts.

## Non-Impacting

Low vibration levels make these tools comfortable and safe for the operator to use. In addition there is less damage to the tool, socket and threaded assembly.

## Replaceable Drive Square

To avoid internal damage to the tool (especially due to torque overload), the output drive square has been designed to shear first. PneuTorque® tools are fitted with a drive square that can easily be replaced; alternative drive square sizes may be available.

## Hanger

The hanger can be used to suspend the PneuTorque® from a balancer.

# SET UP INSTRUCTIONS

The PneuTorque<sup>®</sup> set up covers the following items:

1. PneuTorque<sup>®</sup> Hanger
2. Connecting Air Supply
3. Connecting Electric Supply
4. Air Lubrication
5. Torque Reaction
6. Clockwise / Counter-Clockwise
7. Setting Shut-Off Torque/ Angle

Please complete the set up in the order shown.

## PneuTorque<sup>®</sup> Hanger

The PneuTorque<sup>®</sup> hanger (Figure 1-E) is designed to be used with a suitable balancer to provided comfortable tool use. Remove hanger if not required.

## Connecting Air Supply



**WARNING: TO AVOID HAZARD FROM WHIPPING AIR HOSES MAKE ALL CONNECTIONS TO THE TOOL BEFORE TURNING ON THE AIR SUPPLY.**

Make sure all hoses are clean, in good condition and free from dirt / water.

Connect the tool air inlet hose (Figure 1-C) to the outlet side of the lubro control unit (Figure 1-B) (not supplied), observing air flow direction arrows.

**TIP: On tools supplied with quick air couplings, fit the coupling plug to the tool inlet and the coupling socket to air hose.**

**To connect, push couplings together.**

**To disconnect, pull back lock on socket coupling.**



Connect the inlet side of the lubro control unit (Figure 1-B) to the air supply (Figure 1-A) using a minimum hose size of 1/2" bore (12mm). Avoid using 1/2" bore hoses of longer than 5 meters from the supply to the pressure regulator unit as this will reduce the performance of the tool.

Turn on air supply and check for air leaks.

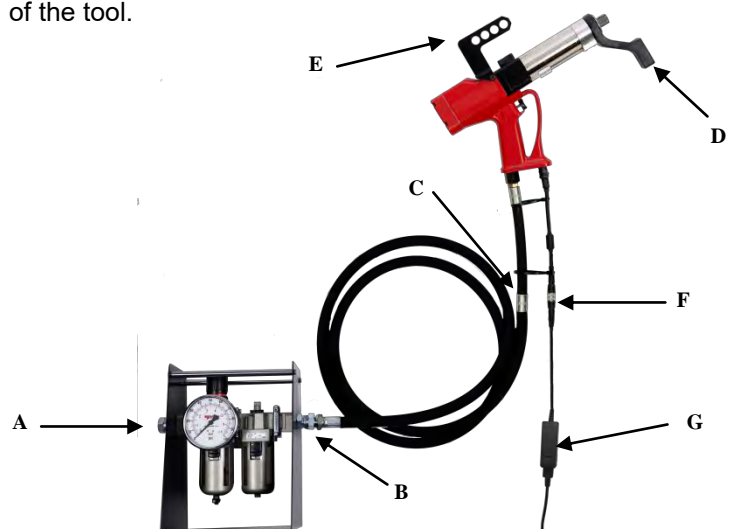

FIGURE 1 – Connections



## Connecting Electricity Supply

Attach the power supply extension lead between the power tool lead (Figure 1-F) and the power supply (Figure 1-G).

Fit the mains power lead to the power supply (Figure 1-G). The display and LED's will illuminate for a short time.

**TIP:** If the power lead has no plug fitted, wire as follows:

**BROWN-LIVE**

**BLUE-NEUTRAL**

**GREEN / YELLOW-EARTH**

## Air Lubrication

The tool must be used with oil lubrication in the supplied air, this is achieved by using a Lubro Control Unit (not supplied).

Set the air lubrication:

- Fill Lubro Control Unit with hydraulic oil (Shell Tellus S2M 32 or equivalent good quality hydraulic oil).
- Ensure the tool drive square is free to rotate.
- Run the tool by pressing the trigger.
- Adjust the Lubro Control Unit for maximum tool air pressure. Air pressure is shown on the gauge.

**TIP:** Using maximum air pressure will give maximum tool speed.

- Adjust Lubro Control Unit to supply 6 drops of oil per minute.
- Release trigger.



**IMPORTANT:** THE WRENCH MUST BE FREE RUNNING WHILE ADJUSTING THE AIR PRESSURE TO GIVE THE CORRECT SETTING.

See Lubro Control Unit handbook for more details.

## Torque Reaction

The reaction bar ensures all reaction forces are contained, so torque reaction is not passed back to the operator. Several reaction bar types are available.

Fit reaction bar as detailed below:

Tool Model	Reaction Bar Type	Fitting Instructions
PTM	Cranked reaction bar (standard)	Fit reaction bar / plate (Figure 1-D) over the drive square to engage reaction splines. Secure with circlip supplied.
	Single sided reaction plate (option)	
	Double sided reaction plate (option)	
PTM	Nose Extension (option)	Fit as instructions supplied with nose extension.
PTME	Nose Extension (Standard)	Factory fitted, not removable.



It is essential the reaction bar rests squarely against a solid object or surface adjacent to the fastener to be tightened. The contact area must be within the shaded area of figure 2, with the contact area as large as possible.

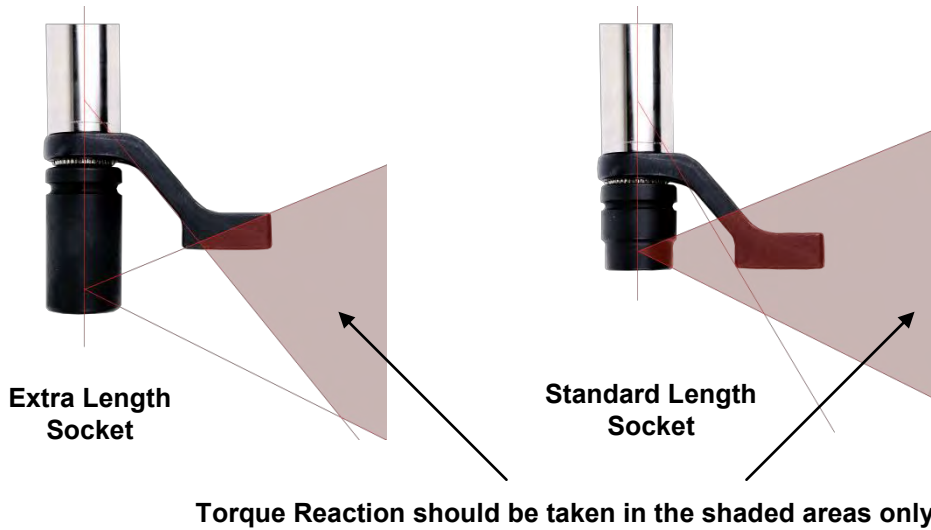

FIGURE 2 – Safe reaction window



**WARNING: CARE MUST BE TAKEN TO ENSURE THAT THE REACTION BAR IS ONLY USED WITHIN THE LIMITATIONS SHOWN IN FIGURE 2.**

For special applications or where extra deep sockets must be used the standard bar may be extended but only within the limitations shown on Figure 2. Alternative reaction bars are available, see page 5.



**WARNING: FAILURE TO OBSERVE THE LIMITATIONS SHOWN IN FIGURE 2 WHEN MODIFYING STANDARD REACTION BARS MAY RESULT IN PREMATURE WEAR OR DAMAGE TO THE TOOL.**

Standard drive square extensions MUST NOT be used as these will cause serious damage to the tool output drive. A range of nose extensions is available for applications where access is restricted. These are designed to support the final drive correctly.

The dimensions of the standard reaction bars are shown in the following table:

Reaction Bars (Standard)		Tool	'L'	'A'	'B'	'W'	'SQ'
		PTM-52	60	131	71	35	3/4"
		PTM-72	75	165	91	48	1"
Reaction Bars (PTME)		Tool	'L'	'A'	'B'	'W'	'SQ'
		PTME-72 (1000 N·m)	80.5	110	63	12	3/4"
		PTME-72 (2000 N·m)	51.5	110	62	16	1"

When the PneuTorque<sup>®</sup> is running the reaction bar rotates in the opposite direction to the output drive square and must be allowed to rest squarely against a solid object or surface adjacent to the fastener to be tightened. See figure 3(a), 3(b), 3(c) and 3(d).

PneuTorque <sup>®</sup> Model	Torque Reaction	
	Clockwise	Counter-Clockwise (Bi Directional Tools Only)
Example of PTM tool.	 <p><b>FIGURE 3(a)</b></p>	 <p><b>FIGURE 3(b)</b></p>

Example of PTM tool with nose extension option or PTME tool.



**FIGURE 3(c)**



**FIGURE 3(d)**



**WARNING:** ALWAYS KEEP HANDS CLEAR OF THE REACTION BAR WHEN THE TOOL IS IN USE OR SERIOUS INJURY MAY RESULT.



## Clockwise / Counter-Clockwise

Set clockwise / counter-clockwise as required. Angle measurement is accurate in the clockwise direction only.

**NOTE:** This setting only applies to bi-directional tools.

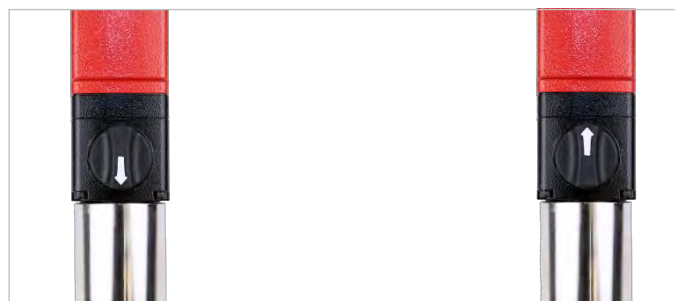

**FIGURE 4(a) – Clockwise**  
(Arrow towards drive square)

**FIGURE 4(b) – Counter-Clockwise**  
(Arrow away from drive square)



**WARNING:** FAILURE TO FULLY ENGAGE THE CLOCKWISE / COUNTER- CLOCKWISE SELECTOR WILL RESULT IN DAMAGE TO THE GEARBOX.

## Setting Shut-Off Torque/ Angle

The torque applied by the PneuTorque<sup>®</sup> depends on the shut-off setting.

The following values need to be entered:

Tool Display	Description
unit	Torque units (lbf·ft / N·m)
AnGLE	Angle measurement (On/OFF): tool dependant
SnuG	Torque value to start angle measurement (if AnGLE On)
°	Shut-off angle ((if AnGLE On))
Hi	High limit for torque operation (if AnGLE OFF)
Lo	Low limit for torque operation (if AnGLE OFF)
StOP	Shut-off torque (if AnGLE OFF)
SEc	Reset time
Fin	Finish

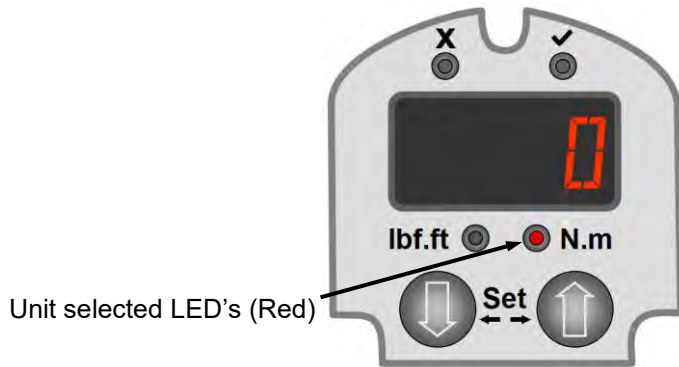

FIGURE 5a – Tool Torque Display

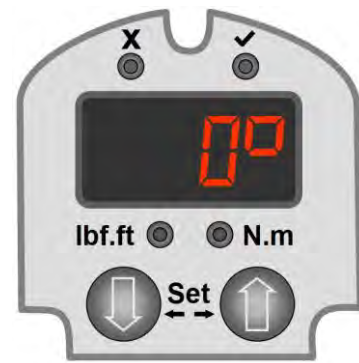

FIGURE 5b – Tool Angle Display

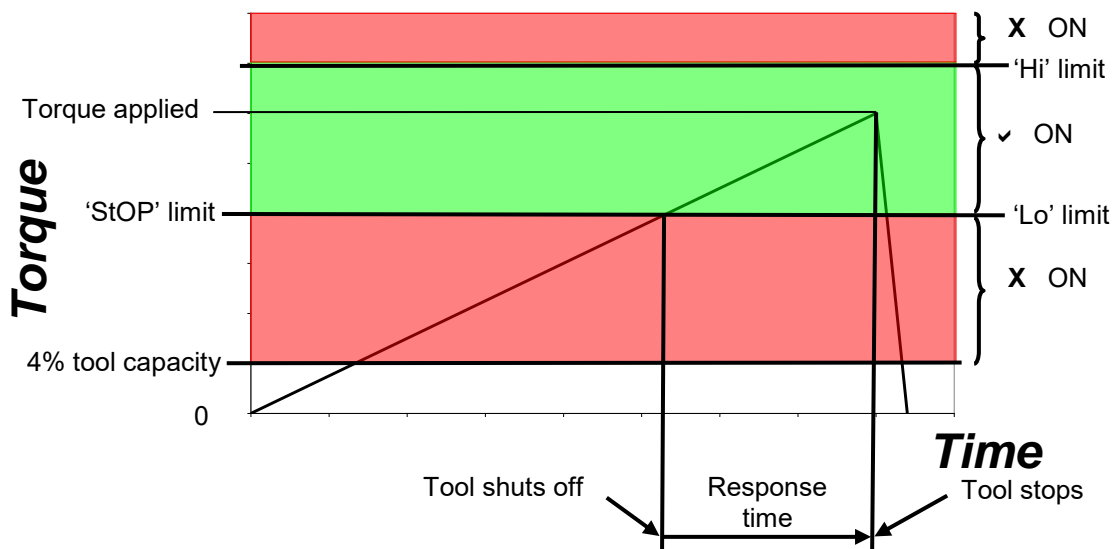

FIGURE 6 – Typical Torque Application

**NOTE:** The tool will not operate whilst setting the shut-off torque or angle.

**TIP:** When altering the limit settings press and hold ↓ or ↑ to increase speed of change.

Step	Setting	Minimum Setting	Maximum Setting
Power up tool.			
Press ↓ and ↑ simultaneously.	<u>UNIT</u> 'unit' displayed. Press ↓ to set N·m or lbf·ft.		
Press ↓ and ↑ simultaneously.	<u>AnGLE</u> 'AnGLE' and 'setting' displayed alternately. Press ↓ to toggle angle mode.	<b>OFF.</b>	<b>On.</b>
Press ↓ and ↑ simultaneously.	<u>Hi LIMIT</u> (if AnGLE = OFF) 'Hi' and 'high limit value' displayed alternately. Press ↓ or ↑ to set the high limit.	<b>20% of tool capacity.</b>	<b>120% of tool capacity.</b>
Press ↓ and ↑ simultaneously.	<u>Lo LIMIT</u> (if AnGLE = OFF) 'Lo' and 'low limit value' displayed alternately. Press ↓ or ↑ to set the low limit.	<b>4% of tool capacity.</b>	<b>Hi limit setting</b> (100% tool capacity maximum)
Press ↓ and ↑ simultaneously.	<u>SHUT-OFF</u> (if AnGLE = OFF) 'StOP' and 'shut-off value' displayed alternately. Press ↓ or ↑ to set the shut-off value. <b>NOTE: 'StOP' is initially set to 'Lo' limit.</b>	<b>4% of tool capacity.</b>	<b>Mid-point between Hi and Lo limits.</b> (100% tool capacity maximum).
Press ↓ and ↑ simultaneously.	<u>SnuG</u> (if AnGLE = On) 'SnuG' and 'snug value' displayed alternately. Press ↓ or ↑ to set the snug torque value when angle measurement starts.	<b>5% of tool capacity.</b>	<b>50% of tool capacity.</b>
Press ↓ and ↑ simultaneously.	<u>O</u> (if AnGLE = ON) 'O' and 'angle value' displayed alternately. Press ↓ or ↑ to set the angle shut-off value.	<b>10 degrees.</b>	<b>9999 degrees</b>
Press ↓ and ↑ simultaneously.	<u>RESET TIME</u> 'Sec#' displayed. The reading is held for # seconds after shut-off, then resets.  If set to 'Sec0', tool resets after 3 seconds, but the reading is held until the next torque application.	<b>1 second.</b>	<b>9 seconds.</b>
Press ↓ and ↑ simultaneously.	'Fin' displayed.  The tool is ready for use.		

**TIP:** Trial the tool on the fastener and check the actual torque applied.

If the torque applied (AnGLE = OFF) is consistently above the torque required then the 'StOP' limit can be reduced.

If the torque applied (AnGLE = OFF) is consistently below the torque required then the 'StOP' limit can be increased.

# OPERATING INSTRUCTIONS



**WARNING:** KEEP HANDS CLEAR OF THE REACTION BAR.



**WARNING:** WHEN USING THIS TOOL IT MUST BE SUPPORTED AT ALL TIMES IN ORDER TO PREVENT UNEXPECTED RELEASE IN THE EVENT OF FASTENER OR COMPONENT FAILURE.

## Tightening

**NOTE:** Ensure 'SET UP INSTRUCTIONS' have been followed.

1. Fit the PneuTorque<sup>®</sup> with the correct size impact or high quality socket to suit fastener.

**TIP:** For added safety it is recommended to secure the socket to the drive square. This is often achieved using a pin and O ring, see socket manufacturer for guidance.

2. Ensure shut-off torque has been set for current fastener.
3. Ensure the clockwise / counter-clockwise selector is correctly set. Angle measurement is accurate in the clockwise direction only.

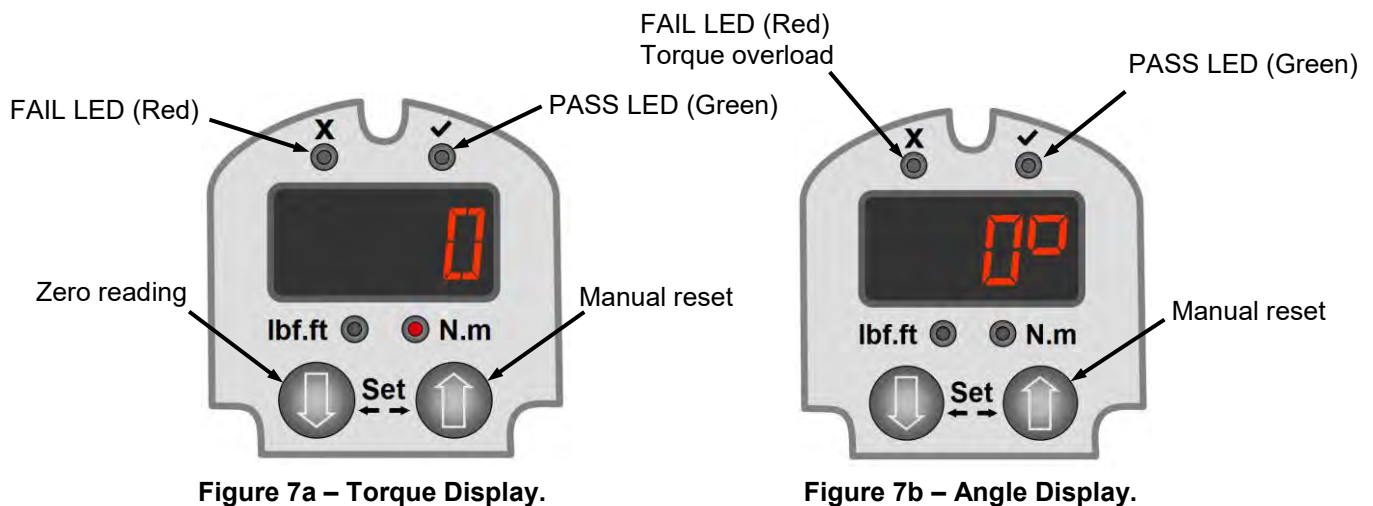

4. Press ↓ to zero the reading in torque mode (ANGLE = OFF).
5. Press ↑ to reset the reading in torque mode and torque and angle mode.
6. Rotate the handle into a convenient position relative to the reaction bar. Fit the tool onto the fastener to be tightened with the reaction bar adjacent to the reaction point. See Figure 8.
7. Adopt a suitable posture to counteract normal or unexpected movement of the tool due to reaction forces.
8. Squeeze the trigger partially to bring the reaction bar into contact with the reaction point.
9. Fully press trigger and keep fully pressed until tool shuts off, then release trigger. If the trigger is not fully pressed full torque or angle may not be applied to the fastener.
10. The trigger must be released before the tool resets to prevent a further joint application.

- The display captures the peak torque (AnGLE = OFF) or peak angle (AnGLE = ON) and holds this value for the reset time of between 1 second and 9 seconds when the tool automatically resets.

Note the status of the PASS / FAIL LED's:

(AnGLE = OFF)

Limit LED Colour	Fastener Indication
None	Below 4% tool capacity
RED (x)	Torque fail (low or high)
GREEN (✓)	Torque pass

(AnGLE = ON)

Limit LED Colour	Fastener Indication
None	
RED (x)	Fail (Torque capacity reached before angle )
GREEN (✓)	Angle pass

- Remove the tool from the fastener.
- Press  $\uparrow$  to manually reset the tool and display if required.



FIGURE 8 – Tightening Clockwise Fastener



## Releasing

1. Fit the PneuTorque<sup>®</sup> with the correct size impact or high quality socket to suit the fastener to be released.

**TIP:** For added safety it is recommended to secure the socket to the drive square. This is often achieved using a pin and O ring, see socket manufacturer for guidance.

2. Ensure the clockwise / counter-clockwise selector is correctly set.
3. Rotate the handle into a convenient position relative to the reaction bar. Fit the tool onto the fastener to be released with the reaction bar adjacent to the reaction point. See Figure 9.
4. Adopt a suitable posture to counteract normal or unexpected movement of the tool due to reaction forces.
5. Squeeze the trigger partially to bring the reaction bar into contact with the reaction point.
6. Fully press trigger and keep fully pressed until threaded fastener releases.

**TIP:** If unable to release the fastener due to the tool shutting off, increase the 'StOP' limit. If unable to release the fastener due to the tool stalling, increase the air pressure to the tool. Do not exceed the maximum air pressure for the tool.



**WARNING:** EXCEEDING THE MAXIMUM AIR PRESSURE WILL CAUSE OVERLOADING AND MAY LEAD TO SERIOUS DAMAGE.



FIGURE 9 – Releasing Clockwise Fastener



# MAINTENANCE

For optimum performance and safety, regular tool maintenance is required. The operator maintenance is limited to the replacement of the drive square and the silencer. All other maintenance and repair should be carried out by Norbar or a Norbar distributor. Maintenance intervals will depend on the tool usage and the environment in which it is being used. The maximum recommended maintenance and recalibration interval is 12 months.

**TIP:** Steps the operator can take to reduce the amount of maintenance required include:

1. Use the tool in a clean environment.
2. Use an air compressor fitted with a dryer.
3. Ensure the Lubro Control Unit has sufficient hydraulic oil.
4. Ensure the Lubro Control Unit delivers hydraulic oil at the correct rate.
5. Ensure the Lubro Control Unit is regularly maintained, see product handbook.
6. Maintain the correct torque reaction.

## Air Lubrication

Add Shell Tellus S2M 32 or equivalent good quality hydraulic oil to the Lubro Control Unit.

## Gearbox

Under normal operating conditions it is not necessary to re-grease the gearbox. The gearbox contains Lubcon Turmogrease Li 802 EP or equivalent good quality grease.

## Silencer

The silencer (part number 18591) must be changed every 12 months. This may be more frequent for high tool usage or dirty environments.

**TIP:** Change silencer with tool upside down, as shown, to ensure internal parts (spring & valve) are kept in place.

1. Remove M4 screw (A) (part number 25381.10) using a 2.5mm hexagon key.
2. Remove pin (B) (part number 26284) using a pin punch.
3. Pull out air inlet tube (D) with base plate & silencer.
4. Remove silencer (E) from air inlet tube.
5. Fit new silencer (part number 18591) over air inlet tube.
6. Fit air inlet tube assembly (C, D & E) into handle against spring resistance.
7. Fit pin (B) with a hammer.
8. Fit screw (A) and torque to 0.5 N·m. Do not over tighten this screw as it is likely to break the base plate moulding.

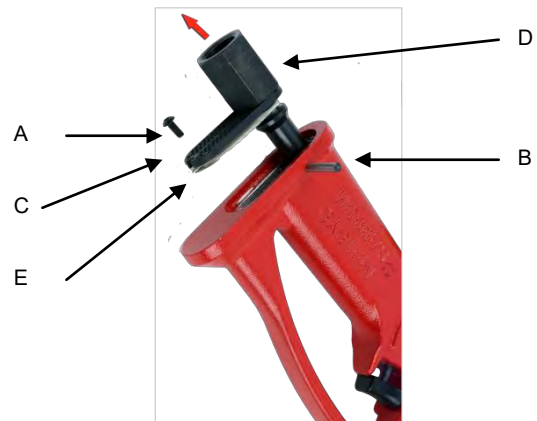

**FIGURE 10 – Silencer Replacement**

**TIP:** When refitting air inlet tube assembly into handle care should be taken to ensure correct alignment between air inlet tube & spring. It may be easier to fit the spring into air inlet tube first and secure with a small amount of grease.

## Drive Square

To avoid internal damage (especially due to torque overload), the output drive square has been designed to shear first. This saves major internal damage and allows easy square removal. For drive square part numbers see page 5.



**FIGURE 11 – Drive Square Replacement**

To replace drive square:

1. Remove the air supply.
2. Support tool in a horizontal position
3. Remove the screw or spring pin, then remove drive square.  
If the square has sheared it may be necessary to use pliers to remove the broken parts
4. Fit new drive square.
5. Fit new screw and tighten between 4 N·m to 5 N·m (for PTM52) or 8 N·m to 9 N·m (for PTM72/92/119) or insert new spring pin.
6. Connect air supply.

**TIP:** If the drive square fails continually then seek advice from Norbar or a Norbar distributor.

## Calibration

To maintain the PneuTorque® accuracy it is recommended the tool is recalibrated at least every 12 months. Contact Norbar or a Norbar distributor for more information.

## Cleaning

Keep the tool in a clean condition to aid safety. Do not use abrasives or solvent based cleaners.

## Disposal

Recycling Considerations:

Component	Material
Handle	Aluminium case / Steel internals
Gearbox (clockwise / counter-clockwise)	Aluminium case / Steel internals
Gearbox (52mm / 72mm)	Steel with nickel plated case / Steel internals
Reaction bar	PTM-52 is steel / PTM-72 is aluminium

# SPECIFICATIONS

Part Number	Torque	
	Minimum	Maximum
18110.B06 / 18125.B06	100 N·m (74 lbf·ft)	500 N·m (370 lbf·ft)
18111.B06 / 18126.B06	160 N·m (118 lbf·ft)	800 N·m (590 lbf·ft)
18112.B06 / 18127.B06 / 18142.B06	200 N·m (147 lbf·ft)	1000 N·m (738 lbf·ft)
18113.B08 / 18128.B08	270 N·m (200 lbf·ft)	1350 N·m (1000 lbf·ft)
18114.B08 / 18129.B08 / 18143.B08	400 N·m (295 lbf·ft)	2000 N·m (1475 lbf·ft)

Part Number	Dimensions (mm)				Tool Weight (kg)	Reaction Weight (kg)
	H	W	R	L		
18110.B06	324	82	60	434	4.9	0.85
18111.B06	324	82	60	434	4.9	0.85
18112.B06	324	85.7	75	465	7.4	0.7
18113.B06	324	85.7	75	465	7.4	0.7
18114.B08	324	85.7	75	498	7.8	0.7
18125.B06	324	82	60	441	5.0	0.85
18126.B06	324	82	60	441	5.0	0.85
18127.B06	324	85.7	75	469	7.5	0.7
18128.B08	324	85.7	75	469	7.5	0.7
18129.B08	324	85.7	75	505	7.9	0.7
18142.B06	324	82	80.5	555	8.5	-
18143.B08	324	82	80.5	555	9.0	-

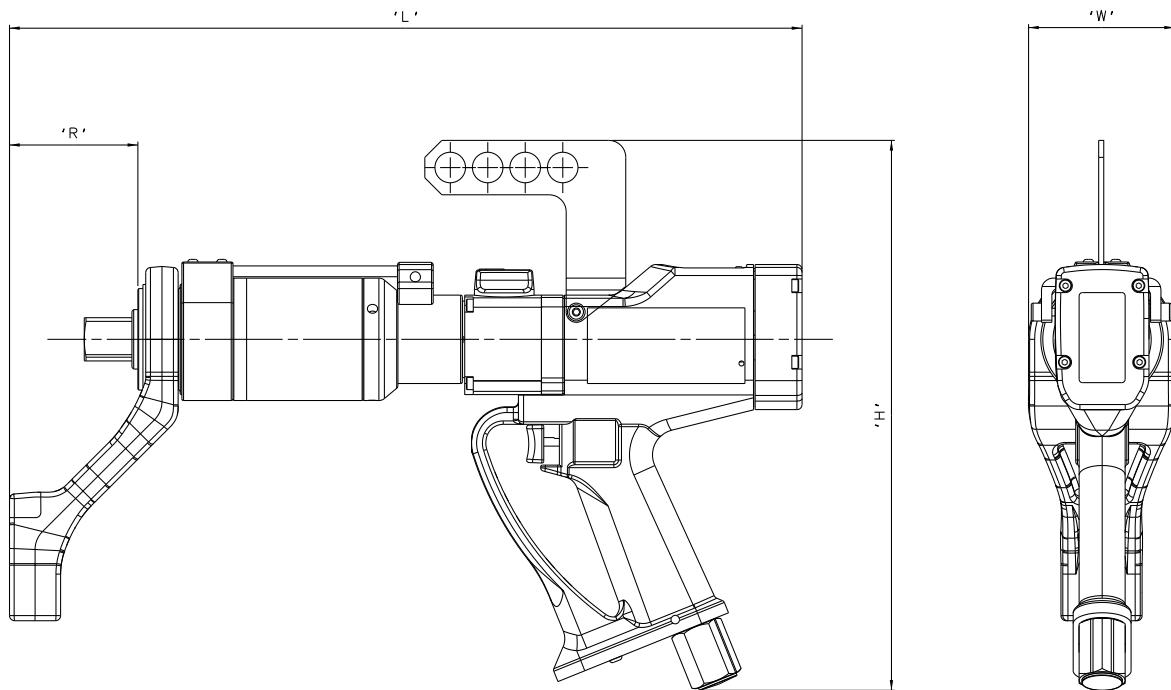

**FIGURE 12 – Tool Dimensions**

Part Number	Tool Speed (free running at maximum air pressure)	Drive Square
18110.B06 / 18125.B06	224 rev/min	3/4"
18111.B06 / 18126.B06	148 rev/min	3/4"
18112.B06 / 18127.B06 / 18142.B06	122 rev/min	3/4"
18113.B08 / 18128.B08	86 rev/min	1"
18114.B08 / 18129.B08 / 18143.B08	58 rev/min	1"

Repeatability:	Torque shut-off: $\pm 2\%$ of reading. Angle shut off: $\pm 1$ degree of rotation
Accuracy:	Torque shut off: $\pm 2\%$ of reading. Angle shut off: $\pm 1$ degree of rotation: 6 degrees in 999 degrees maximum
Display:	4 digit LED with refresh rate of 2.5 times per second.
Units of Measurement:	Newton metres (N·m) or pound force foot (lbf·ft.) - Operator selectable.
Reset Time:	1, 2, 3, 4, 5, 6, 7, 8 or 9 seconds - Operator selectable.
Air Supply:	Maximum pressure 6.3 bar (For maximum output speed).
Lubrication:	Shell Tellus S2M 32 recommended for the Lubro Control Unit.
Temperature Range:	+5°C to +40°C (operating). -20°C to +60°C (storage).
Operating Humidity:	85% Relative Humidity @30°C maximum.
Power Adapter:	100 to 240 Volts $\pm 10\%$ AC at 50-60 Hz input.
Power Consumption:	15 W - maximum.
Power Plug Fuse (if fitted):	1 Amp.
Power Cable:	2 meters (6ft 6ins) long minimum.
Extension Cable:	3 meters (9ft 9ins.) long minimum.
Handle Vibration:	< 2.5 m/s <sup>2</sup> Maximum. Tested in accordance with ISO 8662-7 Hand held portable tools. Measurement of vibrations at the handle.
Sound Pressure Level:	84 dBA measured at 1m equivalent continuous A weighted sound. Tested to BS ISO 3744: 1994 Acoustics. Determination of sound power levels of noise sources using sound pressure. Engineering method in an essentially free field over a reflecting plane. Test conducted in free running condition with a supply pressure of 6.3 bar.
Environment:	Indoor use within a light industrial environment. To environmental conditions Pollution Degree 2 & Installation Category (Over voltage Category) II. Store in a clean & dry environment.

*Due to continuous improvement all specifications are subject to change without prior notice.*

**NOTE: If equipment is used in a manner not specified by the manufacturer, the protection provided by the equipment could be impaired.**



Norbar Torque Tools Ltd  
 Beaumont Road  
 Banbury  
 Oxfordshire  
 OX16 1XJ  
 United Kingdom  
 Tel: + 44 (0) 1295 270333  
 Fax: + 44 (0) 1295 753643  
 E-mail: [enquiry@norbar.com](mailto:enquiry@norbar.com)

Registered in England No.380480  
 VAT No. GB 119 1060 05

QA57  
 ISSUE 2  
 24.1.97

## Declaration of Conformity

**Manufactured by** Norbar Torque Tools Ltd.,  
 Beaumont Road, Banbury, Oxfordshire, OX16 1XJ

### The Directives covered by this Declaration

Safety of Machinery Directive, 2006/42/EC.  
 Electromagnetic Compatibility Directive, 2004/108/EC.  
 Low Voltage Equipment Directive, 2006/95/EC.

### The Equipment Covered by this Declaration

**Equipment:** Pneutorque<sup>®</sup> PTM & PTME Series Internal Control (IC) Shut-Off Tools.

**Model Name(s):** PTM-52-\*\*\*\*-\*.IC  
 PTM-72-\*\*\*\*-\*.IC  
 PTME-52-\*\*\*\*-\*.IC  
 PTME-72-\*\*\*\*-\*.IC

### The Basis on which Conformity is being Declared

The equipment identified above is in compliance with the protection requirements of the above directives, and the following standards have been applied:-

EN 792-6:2000 Hand-held non-electric power tools – Safety requirements  
 Pt 6: Assembly power tools for threaded fasteners  
 EN 61326-1:2006 Electrical equipment for measurement, control and laboratory use  
 EMC requirements.  
 EN 61010-1:2001 Safety requirements for electrical equipment for measurement,  
 control, and laboratory use.

The technical documentation required to demonstrate that the products meet the requirements of the above Directives has been compiled by the signatory below and is available for inspection by the relevant enforcement authorities. The CE mark was first applied in: 2007.

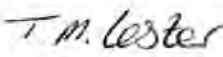
**Signed:**  **Full Name:** Trevor Lester B.Eng.  
**Date:** 19th October 2010 **Authority:** Compliance Engineer

[www.norbar.com](http://www.norbar.com)

United Kingdom • Australia • United States of America • New Zealand • Singapore • China

# TROUBLE SHOOTING

The following is only a guide, for more complex faults please contact Norbar or a Norbar distributor.

Problem	Solution
No display when power is switched on.	Check the power supply is correctly plugged in. Check electrical power supply and fuse in plug (if fitted). Check all connections are secure.
Tool output does not rotate when trigger pressed.	Check air supply is functioning & connected. Check tool is not in 'Setting shut-off torque'. Check air pressure setting (at least 1 bar). Check electrical power. Check clockwise / counter clockwise selector is fully engaged. Gear train or air motor is damaged
Poor repeatability for low applied torque.	Reduce air pressure.
Drive square sheared.	See maintenance section to replace.
Tool stalls – it does not shut-off.	Tool has not achieved torque, increase air pressure. Fastener sheared or thread stripped. Gear train or air motor is damaged. <b>NOTE: Press ↑ button to reset display.</b>
Tool shuts off with Fail LED on. Reading is above HIGH limit.	Reduce shut-off ('StOP') limit. Reduce air pressure setting.
Tool shuts off with Fail LED on. Reading is below LOW limit.	Increase shut-off ('StOP') limit. Increase air pressure setting.
Torque does not return to zero.	Press ↓ button to zero display.
In Angle mode: Tool capacity (in N.m) displayed Fail LED on.	Tool has reached maximum torque capacity before required angle has been reached. Reduce snug torque setting ('SnUG').

# GLOSSARY OF TERMS

Word or Term	Description
A/F	Across Flats.
Bi-directional	Tool capable of Clockwise & Counter-clockwise square rotation.
Fastener	Bolt, stud or nut to be tightened.
IC	Internal Control.
LED	Light Emitting Diode.
Lubro Control Unit	Unit to provide filtering and lubrication along with pressure regulation. Not supplied with tool.
Nose Extension	A reaction type used where tool access is restricted, typical examples on wheel nuts on heavy vehicles. Available as an option for PTM tools or integral for PTME tools.
PneuTorque®	Product name.
PTM	PneuTorque® Twin Motor.
PTME	PneuTorque® Twin Motor with fixed nose extension.
Reaction Bar	Item to counteract applied torque. Also called reaction plate.
Response Time	Time from tool shut-off to tool stopping.
Shut-off	Stop tool at required torque.
Tool Capacity	Maximum torque.
Torque Transducer	Device to measure torque.

**NORBAR TORQUE TOOLS LTD**

Wildmere Road, Banbury,  
Oxfordshire, OX16 3JU  
UNITED KINGDOM  
Tel + 44 (0)1295 270333  
Email enquiry@norbar.com

**NORBAR TORQUE TOOLS PTE LTD**

194 Pandan Loop  
#07-20 Pantech Business Hub  
SINGAPORE 128383  
Tel + 65 6841 1371  
Email enquires@norbar.sg

**NORBAR TORQUE TOOLS**

45-47 Raglan Avenue, Edwardstown,  
SA 5039  
AUSTRALIA  
Tel + 61 (0)8 8292 9777  
Email enquiry@norbar.com.au

**NORBAR TORQUE TOOLS (SHANGHAI) LTD**

7 / F, Building 91, No. 1122, Qinzhou North  
Road, Xuhui District, Shanghai  
CHINA 201103  
Tel + 86 21 6145 0368  
Email sales@norbar.com.cn

**NORBAR TORQUE TOOLS INC**

36400 Biltmore Place, Willoughby,  
Ohio, 44094  
USA  
Tel + 1 866 667 2279  
Email inquiry@norbar.us

**NORBAR TORQUE TOOLS INDIA PVT. LTD**

Plot No A-168, Khairne Industrial Area,  
Thane Belapur Road, Mahape,  
Navi Mumbai – 400 709  
INDIA  
Tel + 91 22 2778 8480  
Email enquiry@norbar.in

**[www.norbar.com](http://www.norbar.com)**